



Instruction Manual and User Guide

PLEASE READ OUR USER GUIDE CAREFULLY BEFORE USE!

CONTENTS

Important Notice	4
Technical Specifications	5
Maintenance	6
Machine Set-up	7
Troubleshooting	15

PRODUCT CHECKLIST

NAME	QUANTITY
Control Unit	1
User Manual	1
Mattress Pad/Accessory*	1
Pipe connector	1
Plastic water release key	1

* Purchased Separately

IMPORTANT NOTICE

Please read before use

It is recommended the HydroSense unit is only lowered to a minimum of 20°C and a maximum of 35° to reduce condensation.

The HydroSense Mattress Pad should be removed from the bed and aired out at least every TWO weeks. Hand wash as required.

Also note; HydroSense units perform more effectively in a temperature controlled room.

Units should only be powered on when in use.

TECHNICAL SPECIFICATIONS

Input Voltage	AC220V	Rated Frequency	50~60Hz
Start Cooling Watt	180W± 10%	Start Warming Watt	200W± 10%
Stay Cooling Watt	80W± 10%	Stay warm Watt	180W± 10%
Noise	≤ 45dB	Warranty	2 Years



Store HydroSense control unit and the pad in a clean and dry place to prevent components from deteriorating or moisture getting into the control unit which will affect its function.



We recommend cleaning the control box every 2 weeks using clean damp cloth or electrostatic-proof cloth, do not use chemical agents (may harm components) or dry cloth to clean the control unit.



MAINTENANCE

A. Clean dirt off window of control unit. Control unit can accumulate dirt and dust around the fan if used for a long time without cleaning, which will affect the function of control unit. Please take off the fan lid to clean or wash, and dry before you reattach it to the control unit.

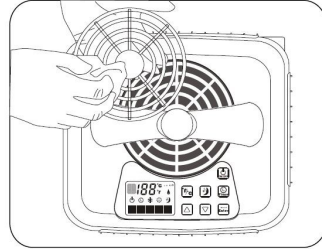
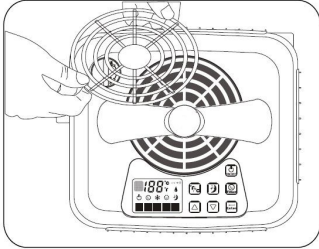

B. Drain the water from control unit and mattress if it won't be used for a long time. If there is dirt or other deposits in the water tank at this time, please release the water and fill with new water. Turning on the control unit, let the water circulate in mattress for two minutes, then drain the water with the plastic key, after draining the water out, re-fill the tank with new water then drain again, repeating two or three times.

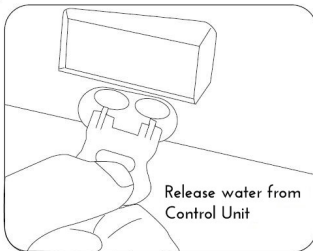

CONTROL UNIT & INSTALLATION

A: Machine appearance instruction

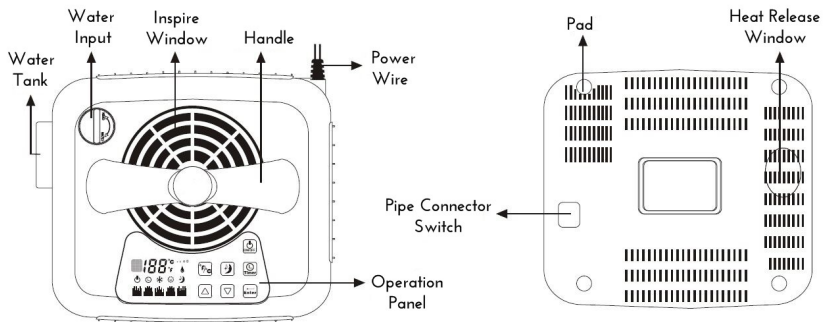

B: Installation Steps

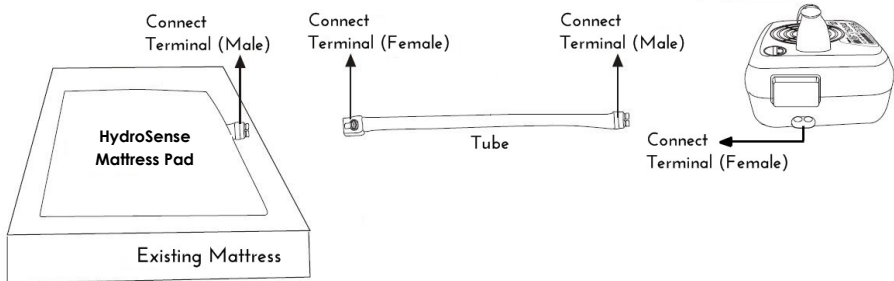

- Mattress pad positioned in place as per diagram.
- Place control unit beside the bed (on the floor)

SET UP

A: Installation Instructions

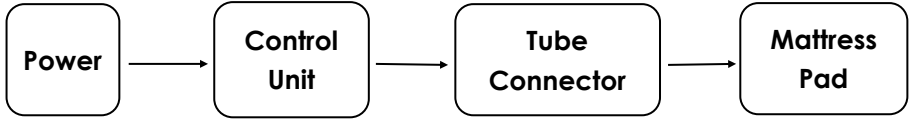

B: Connection between the Mattress Pad and the Control Unit

- 1: Plug the male terminal of the tub connector to the female terminal of the control unit
- 2: Plug the female terminal of the Tube connector to the male terminal of the mattress

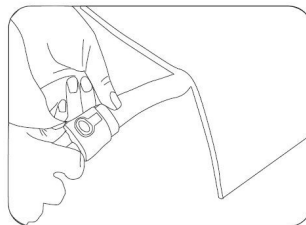
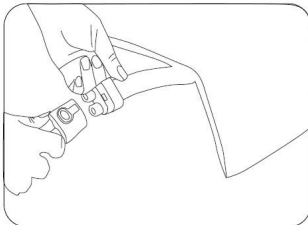
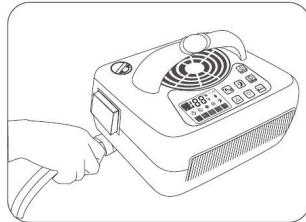
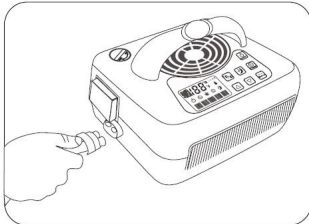

SET UP

Press under button before releasing the tube

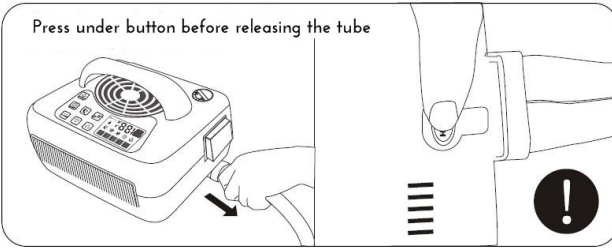

Placing other objects/items within 15cm around the heat releasing windows is prohibited



Be sure to plug into power securely

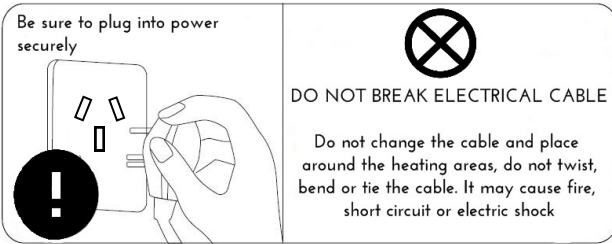

DO NOT BREAK ELECTRICAL CABLE

Do not change the cable and place around the heating areas, do not twist, bend or tie the cable. It may cause fire, short circuit or electric shock

Placing the Control Unit on the mattress is prohibited



Sharp objects placed on the mattress pad is prohibited

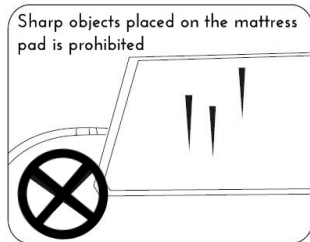

Placing sharp objects on the control unit is prohibited



pouring water into control unit and on buttons is prohibited



SET UP

C. Turn on and add water

Connect the power plug to AC220V/50HZ power. Before you get the control unit working, spin the lid off the water tank and fill with water until the tank is full. Press power button to start the control unit and keep adding water slowly as the tank will deplete as the mattress fills, and once the tank is full again, close the lid.

Please note :

1. Ensure no water is spilt into inside of control unit and operation board.
2. You must refill water when water level in the water tank is under warning level (2/3 of tank) or warning light is on, to make sure the control unit is working normally.



CONTROL UNIT DIRECTIVES

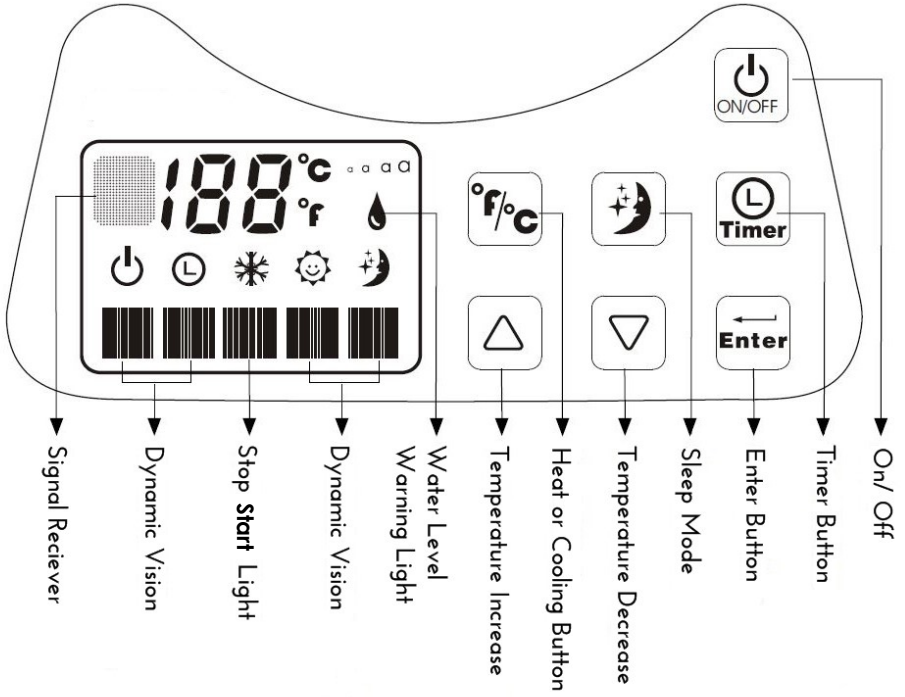

SET UP

Control unit operation guide

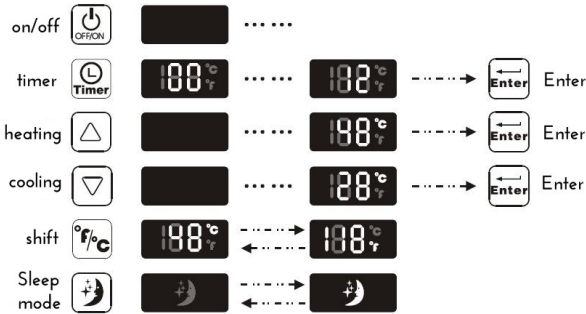

Control unit buttons and lights

CONTROL UNIT BUTTONS AND LIGHTS									
						twinkle	o o o o	°f/°c	
Stop Start	Water Warning	On/off	Timer	Heating	Cooling	Enter	Frequency	Shift	Sleeping Mode

NOTES

Our suggested perfect temperature in warmer conditions is 31°C, in cooler conditions is 35°C.















Lower than 31°C or higher than 37°C is not suitable for long periods of time, but may be required for health reasons. The HydroSense can be set to continue heating or cooling for a long period of time to regulate your sleeping temperature to help you sleep longer & improve medical conditions.

The sleeping mode function can be used if you are not sure about your suitable sleeping temperature, and also for children & seniors who can not help themselves.

Do not put the control unit on the mattress pad, and beware the control unit is just for use on this mattress pad, using it for any other purpose is prohibited.

Will take at least 5 minutes to switch between warming and cooling.

SET UP

	<p>Turn on the control unit and set the temperature according to environmental temperature and personal requirement. Press  button to bring up temperature, press  to bring the temperature down. Pressing once will adjust up or down 1 degree, if you keep pressure on, it goes up or down non-stop to get to user's desired temperature, and then press the  button.</p>
	<p>In hot ambient conditions, no matter how cold you set the control unit, as long as you press  button, the control unit will go back to above 31°C from cooling mode. In cold ambient conditions, no matter how warm you set the control unit, as long as you press  button, the control will go back to under 36°C from heating mode.</p>
	<p>Press  button , the control will shift between Fahrenheit and Celsius heating and cooling measurements. You do not need to press enter.</p>
	<p>When control unit is not working, press  button once, press an hour to time the control unit to user requirements like 12, 11 ... 2, 1 hours, then press  to confirm, the control unit will beep when it has saved the data and will heat or cool automatically to set time. If you want to cancel, just set the number to 00 then press  to confirm</p>
	<p>Press  button to turn the unit on and off.</p> <p>NOTE: Please remove control unit from power source if its going to be unused for a long period of time.</p>

TROUBLE SHOOTING

If any conditions take place like the below, please solve them as stated below. If you still cannot solve the issue, please contact us direct and tell us details of the issue.

Problem	Possible Reason	Troubleshooting
Can not start	No power	Supply with power
	Not connected to power	Connect to power source
	Fuse blown	Replacement of fuse needed
	Will not start but light is on	It shows lack of water, please add water to the tank
	Will not work with all lights on	Shut down the power, clean and dry the operation panels and restart
Not effectively Heating & Cooling	Noise coming from control unit when running	Check the water level in the tank, if it is under the warning line please add water
	Adjusting temperature incorrectly	Adjust temperature to higher or lower
	Heat-absorber was covered or blocked by dirt and dust	Take off the lid and clean
Can not heat or cool	Have a substance block the expire or inspire window or control unit	Clean windows
	Have substance block window of control unit	Clean them
	Not enough water in tank	Add water
If such condition as below starts to happen, please stop using the control unit and promptly turn off power.		
	Fuse burns out frequently	Lost response and buttons are abnormal
	Outside substance or water enters the control unit	Control unit has abnormal smell or noise



HydroSense Effective Heat Management System